

EUROMAP 27-1	Pipe and Profile Extrusion Lines Generic CANopen Interface Part 1: General definitions
---------------------	--

Version 3.3, May 2015
18 pages

This recommendation was prepared by the Technical Commission of EUROMAP in cooperation with CiA.

An identical text is published under CiA 420-1 3.2.0: "CANopen Profiles for extruder downstream devices, Part 1: General definitions";

see also www.can-cia.org/index.php?id=specifications.

History

Date	Changes
2002-10-22	<i>Publication of version 1.0</i>
2004-02-27	<i>Publication of version 2.0</i> Version 2.0 is not at all compatible to version 1.0
2007-04-12	<i>Publication of version 3.0</i> Editorial corrections and clarifications Calibration-table interface added Node-ID assignment recommendations added
2007-07-24	<i>Publication of version 3.1</i> Editorial corrections
2009-01-08	<i>Publication of version 3.2</i> Further supplier added
2015-05-28	<i>Publication of version 3.3</i> Editorial corrections and clarifications Node-ID allocation scheme became mandatory List of plug suppliers removed. Please visit www.euromap.org/technical-issues/technical-recommendations for the current list.

Contents	Page
1 Scope	4
2 Normative references	4
3 Abbreviations and definitions	4
3.1 Abbreviations.....	4
3.2 Definitions.....	4
4 Operating principles.....	4
4.1 Introduction.....	4
4.1.1 Master-extruder	5
4.1.2 Puller downstream device.....	5
4.1.3 Corrugator downstream device	5
4.1.4 Saw downstream device.....	6
4.1.5 Co-extruder downstream device	7
4.1.6 Calibration-table downstream device	7
4.2 Physical layer definitions	8
4.2.1 Hardware adjustments.....	8
4.2.2 Node-ID range	8
4.2.3 Termination resistor	8
4.2.4 Cable definition.....	8
4.2.5 Connector definition.....	8
4.2.6 Emergency-stop wiring	9
4.2.7 CAN bus line wiring	9
4.2.8 Additional discrete measuring wheel interface wiring.....	10
4.2.9 Additional discrete interface wiring.....	10
5 Error handling.....	10
5.1 Principle	10
5.2 Error behavior.....	10
5.3 Emergency message.....	10
6 Predefinitions.....	12
6.1 Record definitions.....	12
6.1.1 Object 0080 _h : Set process data	12
6.2 Predefined communication objects	13
6.2.1 Object 1000 _h : Device type	13
6.2.2 Object 1001 _h : Error register	14
6.2.3 Object 1005 _h : COB-ID SYNC.....	14
6.2.4 Object 1006 _h : Communication cycle period.....	14
6.2.5 Object 1014 _h : COB-ID emergency object.....	14
6.2.6 Object 1016 _h : Heartbeat consumer.....	14
6.2.7 Object 1017 _h : Heartbeat producer	14
6.2.8 Object 1018 _h : Identity	14
6.2.9 Object 1029 _h : Error behavior	15
6.2.10 Object 67FF _h : Device type	17

1 Scope

The CANopen application profile for extruder downstream devices includes several parts:

- Part 1 specifies general definitions
- Part 2 specifies the device profile for the puller downstream device
- Part 3 specifies the device profile for the corrugator downstream device
- Part 4 specifies the device profile for the saw downstream device
- Part 5 specifies the device profile for the co-extruder device
- Part 6 specifies the device profile for the calibration-table downstream device

This part specifies the physical layer and the common CANopen functions and common communication objects. It also specifies the CANopen functions of the extruder-master.

2 Normative references

- /CiA301/: CiA 301, CANopen application layer and communication profile
- /CiA302-1/: CiA 302-1, Additional CANopen application layer functions – Part 1: General definitions
- /CiA302-2/: CiA 302-2, Additional CANopen application layer functions – Part 2: Network management
- /CiA302-3/: CiA 302-3, Additional CANopen application layer functions – Part 3: Configuration and program download
- /CiA302-4/: CiA 302-4, Additional CANopen application layer functions – Part 4: Network variables and process image
- /Euromap28/: Euromap 28, Discrete interface for extruder downstream devices measuring wheel
- /Euromap29/: Euromap 29, Discrete interface for extruder downstream devices after CANopen haul-off
- /Euromap66-1/: Euromap 66-1, Protocol for communication with peripheral equipment – Part 1: General description

3 Abbreviations and definitions

3.1 Abbreviations

Abbreviations given in /CiA301/ shall apply for this document as well.

3.2 Definitions

The definitions given in /CiA420-1/ apply to this specification as well.

4 Operating principles

4.1 Introduction

All devices compliant with this application profile shall implement all mandatory communication services and protocols as well as all mandatory objects as specified in /CiA301/. The extruder downstream devices shall provide CANopen NMT-slave functionality; the master-extruder shall provide additionally CANopen NMT-master functionality as specified in /CiA302-1/ and in /CiA302-2/. It is not allowed to use this CANopen network for local sub-system communication purposes. All CANopen messages shall be transmitted with 11-bit identifiers only.

All devices compliant to this profile shall support heartbeat functionality; Node guarding shall not be supported. The device shall support heartbeat message transmissions from 100 ms to 1000 ms. Extruder downstream devices also shall produce the emergency message.

Extruder downstream devices shall support synchronous PDOs. They shall be able to support Sync cycle times of 20 ms.

It is not required that the extruder downstream devices support block or segmented SDO communication or Multiplexed PDO communication.

4.1.1 Master-extruder

The master-extruder shall implement NMT-slave functionality including the CANopen object dictionary. It may use the object dictionary entry range from 2000_h to 5FFF_h to implement the necessary application objects. Alternatively, the master-extruder may use the object dictionary range from A000_h to AFFF_h, if it is based on IEC 61131-3 programming languages and it is compliant to the definitions given in /CiA302-4/.

The master-extruder shall consume all heartbeats and emergency messages of the networked extruder downstream devices.

The master-extruder shall transmit the Sync message with a default period of 20 ms, periods of 40 ms and of 100 ms may be optionally supported.

4.1.2 Puller downstream device

The puller device is based on rolls, bands, or caterpillars. It requires a high-precise synchronous run with the master-extruder. Figure 1 shows the block diagram of the puller/master-extruder communication.

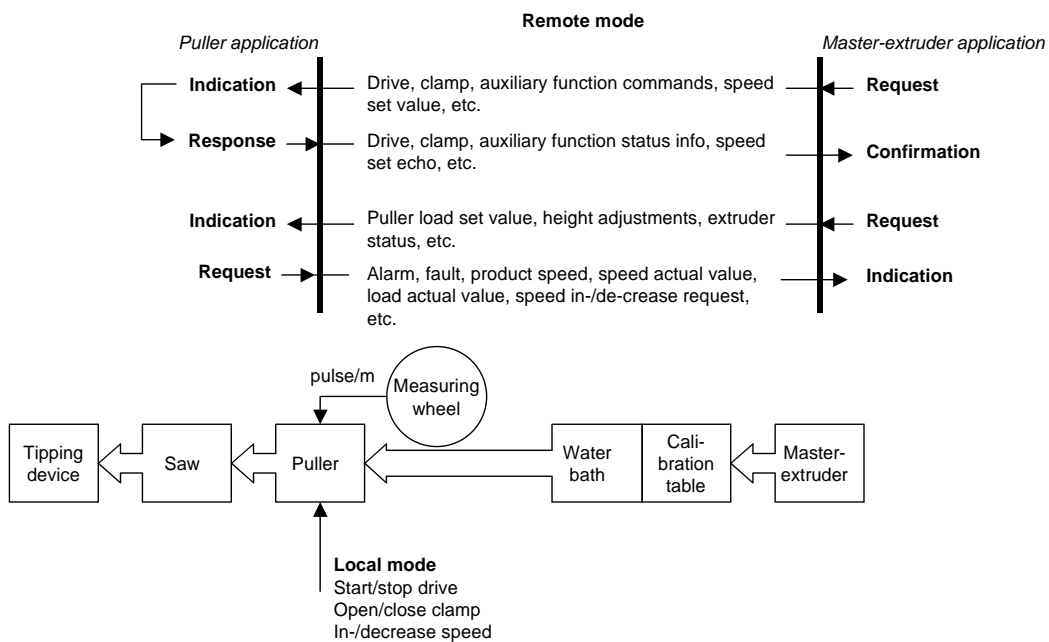

Figure 1 — Puller and master-extruder block diagram

4.1.3 Corrugator downstream device

The corrugator downstream device is used to produce structured wall pipes. Figure 2 shows the block diagram of the corrugator/master-extruder communication.

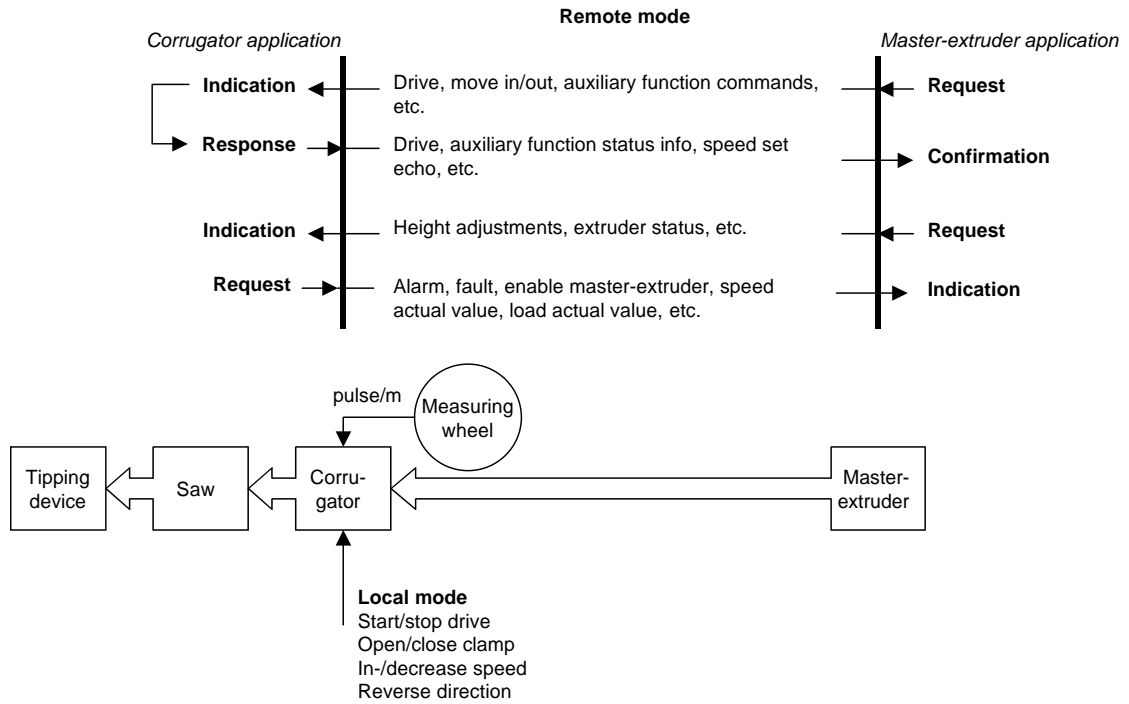

Figure 2 — Corrugator and master-extruder block diagram

4.1.4 Saw downstream device

The saw downstream device saws or cuts off the extruded profiles or pipes. Figure 3 shows the block diagram of the saw/master-extruder communication.

SAW

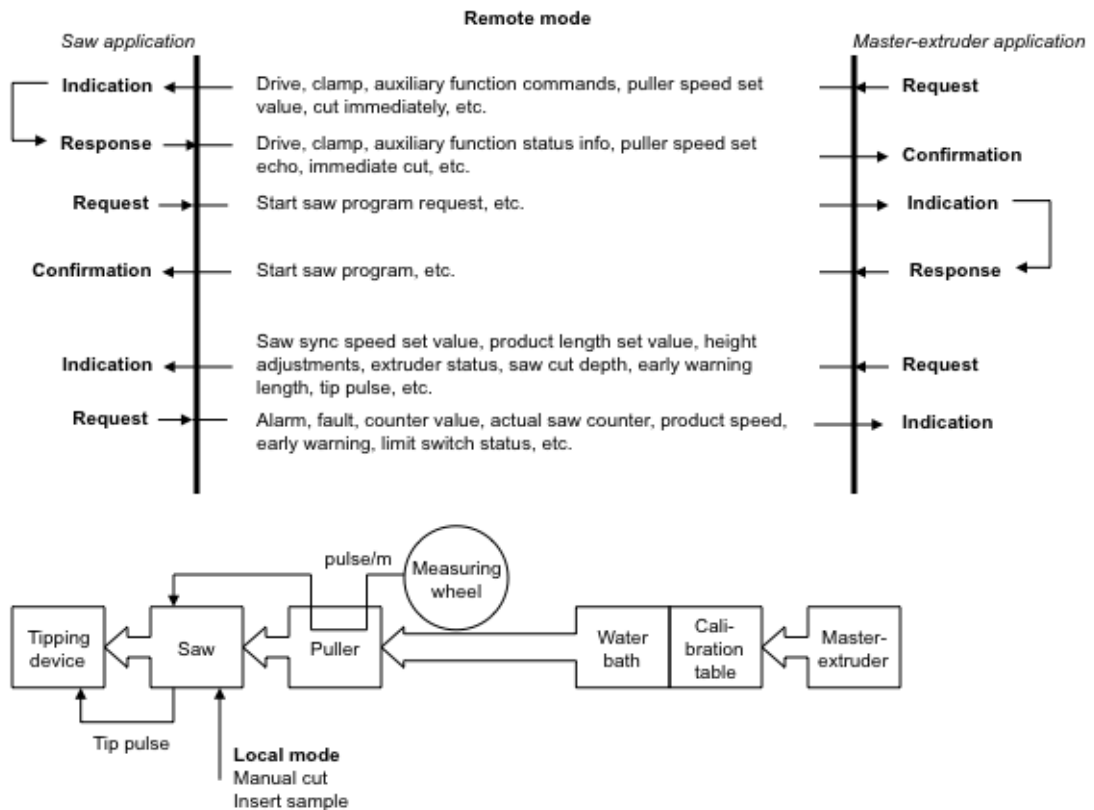

Figure 3 — Saw and master-extruder block diagram

4.1.5 Co-extruder downstream device

The co-extruder downstream device is necessary for example if different materials are used to produce a profile or pipe. Figure 4 shows the block diagram of the co-extruder/master-extruder communication.

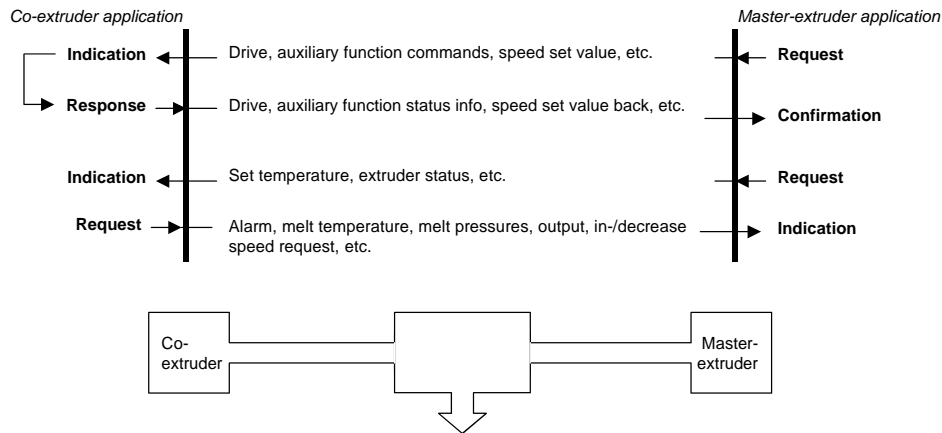

Figure 4 — Co-extruder and master-extruder block diagram

4.1.6 Calibration-table downstream device

The calibration-table downstream device calibrates the profile or pipe. Figure 5 shows the block diagram of the calibration-table/master-extruder communication.

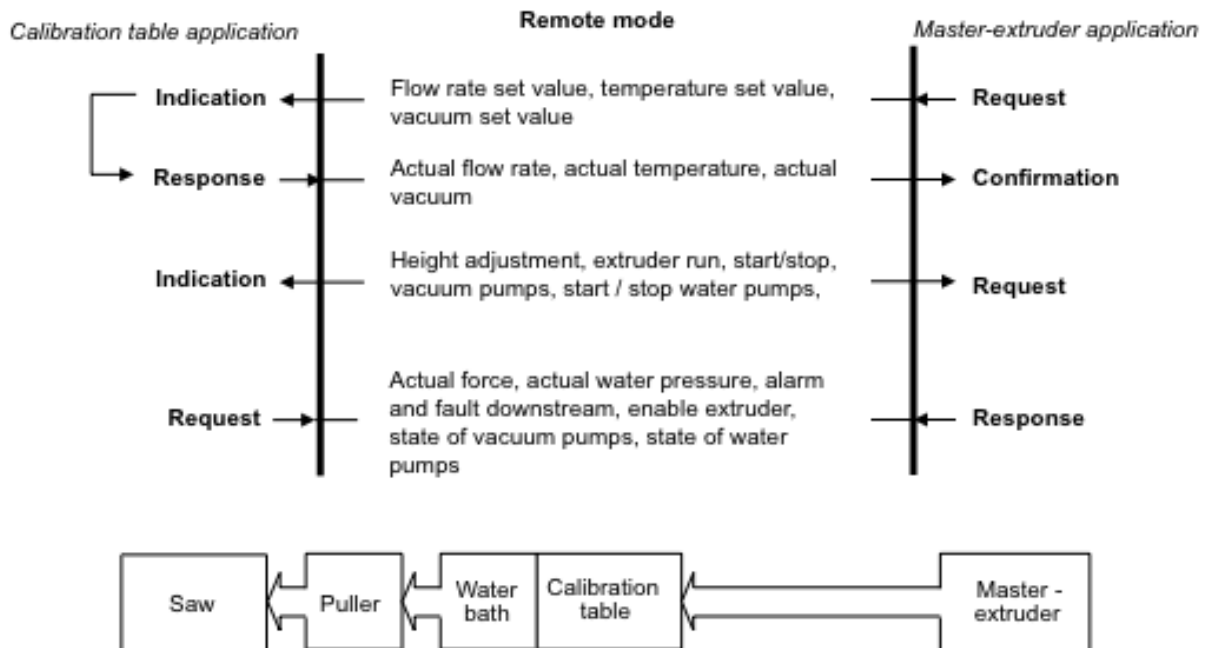

Figure 5 — Calibration-table and master-extruder block diagram

4.2 Physical layer definitions

4.2.1 Hardware adjustments

Bit-rate and node-ID shall be adjustable from outside via DIP-switches or local operator stations. Adjustments via CANopen or programming tools are not allowed. The default bit-rate shall be 250 kbit/s, optional bit-rates are 125 kbit/s and 500 kbit/s. The maximum network length is specified in /CiA301/ clause 5.4 Table 2.

4.2.2 Node-ID range

The assignment of node-IDs is specified in Table 1. In case of multiple CANopen logical devices, first CANopen logical device shall claim the node-ID.

Table 1 — Recommended node-ID assignment

Node-ID range	Device
1	Master-extruder
2 to 16	Co-extruder 1 to 15
17 to 24	Calibration-table 1 to 8
25 to 32	Puller 1 to 8
33 to 40	Corrugator 1 to 8
41 to 48	Saw 1 to 8

4.2.3 Termination resistor

The default termination resistor shall be 120 Ohm.

4.2.4 Cable definition

The used cables shall be compliant to /Euromap66-1/ (see clause 3.1). The schematic connection order of the devices shall be as shown in Figure 6.

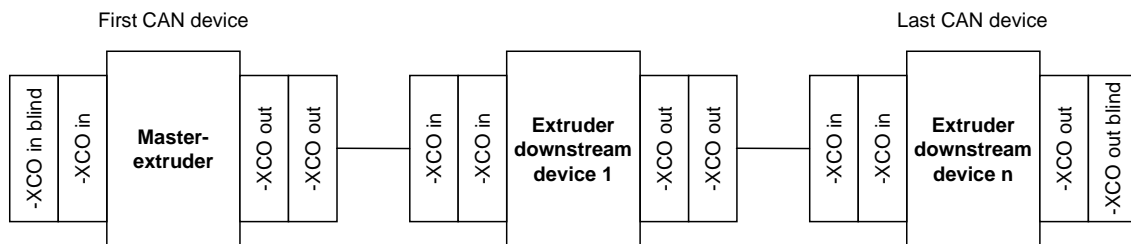

Figure 6 — Schematic connection order of master-extruder and downstream devices

4.2.5 Connector definition

A list of plug suppliers for –XCO in and –XCO out is available for download on the EUROMAP website: www.euromap.org/technical-issues/technical-recommendations

Figure 7 specifies the connector pinning.

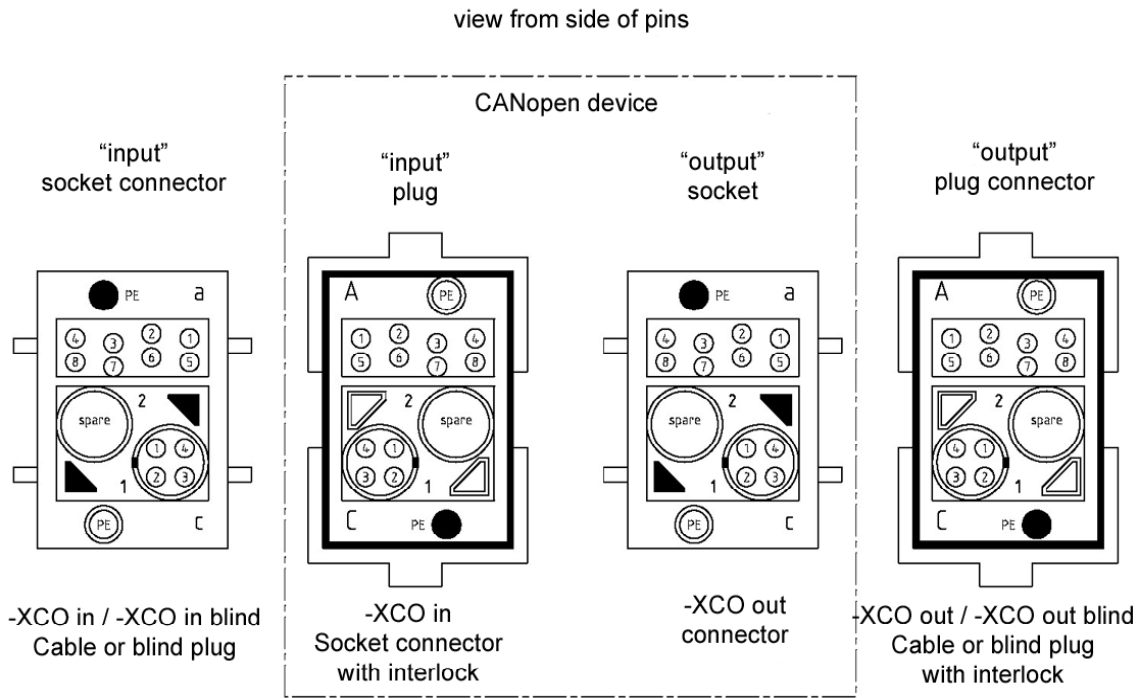

Figure 7 — Pinning of the plug and socket connector

4.2.6 Emergency-stop wiring

The emergency-stop wiring is specified in Figure 8.

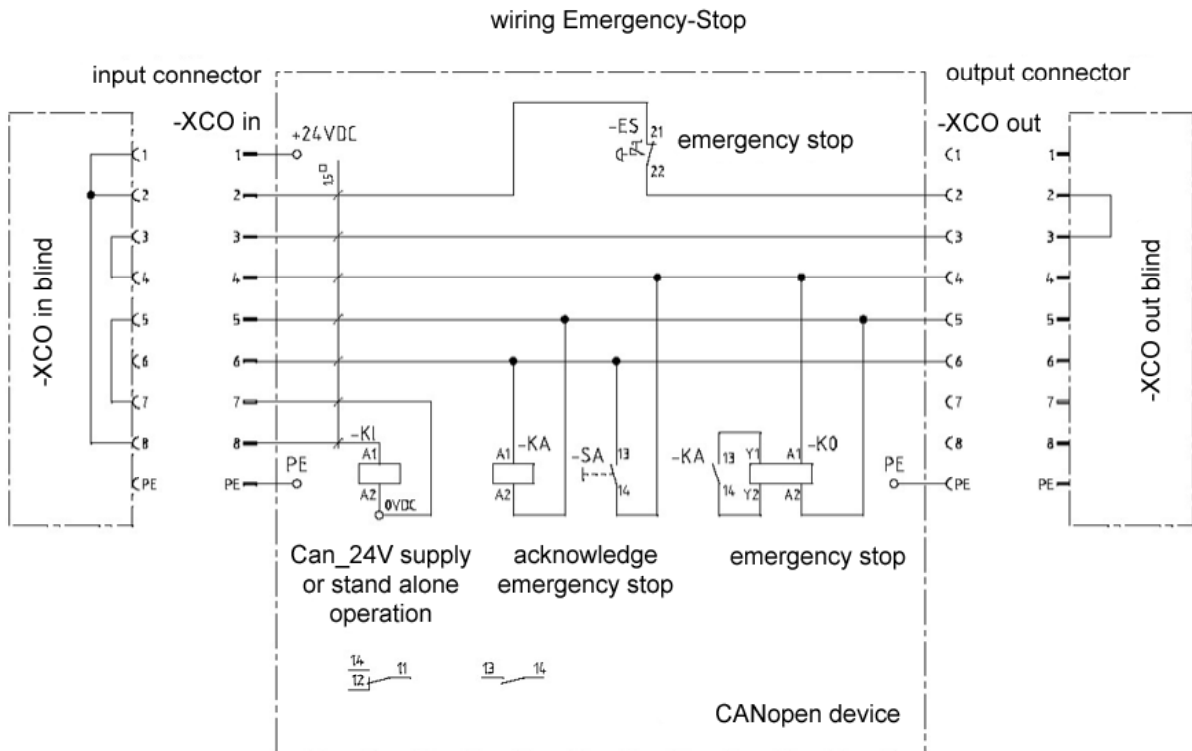

Figure 8 — Emergency-stop wiring

4.2.7 CAN bus line wiring

Figure 9 specifies the CAN bus wiring and Table 2 illustrates the recommended line colors. It is recommended to use 2 x 2 x 0,34 mm² bus-lines.

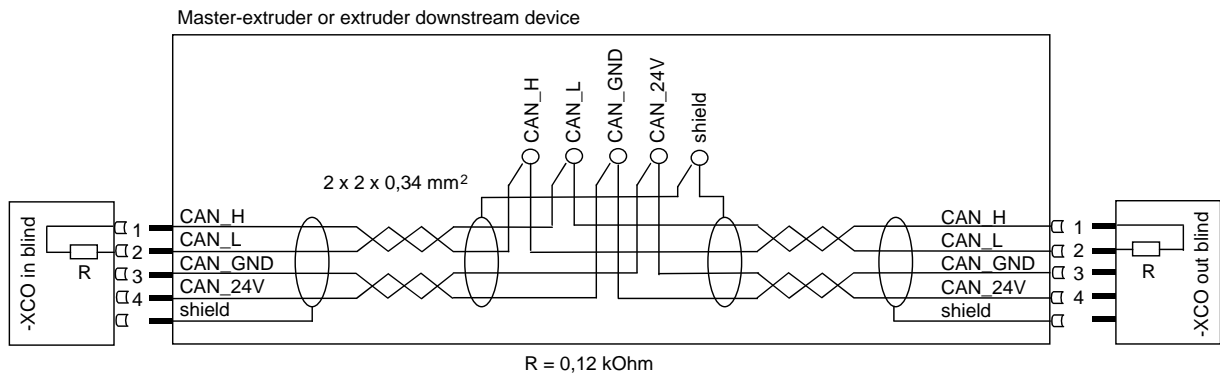

Figure 9 — CAN bus line wiring

Table 2 — Line color recommendation

Line	Color
CAN_H	Yellow
CAN_L	Green
CAN_GND	Brown
CAN_24V	White

4.2.8 Additional discrete measuring wheel interface wiring

If a measuring wheel is used it shall be wired as specified in /Euromap28/.

4.2.9 Additional discrete interface wiring

If a non-CAN interface to a saw or another device is needed it shall be wired as specified in /Euromap29/.

5 Error handling

5.1 Principle

Emergency messages shall be triggered by internal errors in the device and they are assigned the highest possible priority to ensure that they get access to the bus without latency. By default, the Emergency messages shall contain the error field with pre-defined error numbers and additional information.

5.2 Error behavior

If a severe device failure is detected the module shall enter by default autonomously the pre-operational state. If object 1029_h is implemented, the device can be configured to enter alternatively the stopped state or remain in the current state in case of a device failure. Device failures shall include the following communication errors:

- Bus-off conditions of the CAN interface
- Life guarding event with the state ‘occurred’
- Heartbeat event with state ‘occurred’

Severe device errors also may be caused by device internal failures.

5.3 Emergency message

Figure 10 specifies the emergency message structure and Figure 11 specifies the manufacturer-specific error byte (MEB). The emergency error code (EEC) and the error register (ER) are specified in /CiA301/.

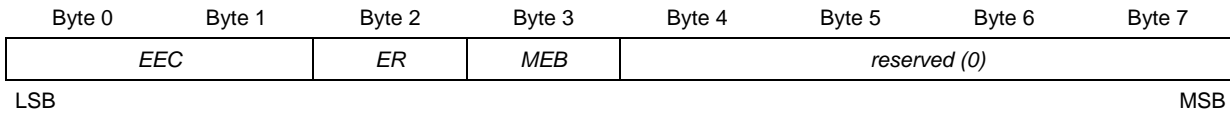

Figure 10 — Emergency message structure

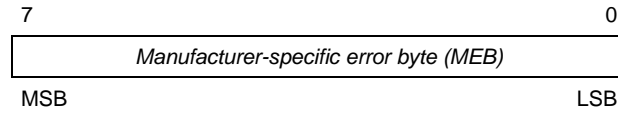

Figure 11 — Manufacturer-specific error byte structure

Table 3 specifies the additional emergency error codes. If an alarm occurs, the production will be continued, at fault the production shall stop.

Table 3 — Emergency error code definitions

EEC	Definition
FF10 _h	Internal puller alarm
FF11 _h	Internal puller fault
FF20 _h	Internal corrugator alarm
FF21 _h	Internal corrugator fault
FF30 _h	Internal saw alarm
FF31 _h	Internal saw fault
FF40 _h	Internal co-extruder alarm
FF41 _h	Internal co-extruder fault
FF50 _h	Internal calibration-table alarm
FF51 _h	Internal calibration-table fault

The manufacturer-specific error byte codes are specified in Table 4.

Table 4 — Manufacturer-specific error byte definition

MEB code	Definition
0 _d	Generic error
1 _d	Emergency stop
2 _d	Safety door(s) open
3 _d	Drive(s) failure
4 _d	Motor(s) temperature high
5 _d	Motor fan(s)
6 _d	Cabinet fan
7 _d	Lubrication system
8 _d	Exhaust unit
9 _d	Air pressure
10 _d	Vacuum system
11 _d	Cooling system
12 _d	Chain break control
13 _d	Power supply
14 _d	Cut not completed
15 _d	Line speed to high
16 _d	Limit switch measuring wheel
17 _d	Min. process temperature

MEB code	Definition
18 _d	Max. process temperature
19 _d	Min. process pressure
20 _d	Max. process pressure
21 _d	Height adjustment
22 _d	Lateral adjustment
23 _d	Traverse unit
24 _d	Material in return travel
25 _d	Max. motor load
26 _d	Measuring wheel not on product
27 _d to 255 _d	reserved

6 Predefinitions

6.1 Record definitions

6.1.1 Object 0080_h: Set process data

Table 5 specifies the record structure. Figure 12 specifies the structure and Table 6 defines the value of the *controller on/off* sub-object. The values of the *set process data 1* to *10* sub-objects are defined in the objects using this data type.

Table 5 — Record structure

Sub-index	Parameter	Data type
00 _h	Highest sub-index supported	UNSIGNED8
01 _h	Controller on/off	UNSIGNED16
02 _h	Set process data 1	INTEGER16
03 _h	Set process data 2	INTEGER16
04 _h	Set process data 3	INTEGER16
05 _h	Set process data 4	INTEGER16
06 _h	Set process data 5	INTEGER16
07 _h	Set process data 6	INTEGER16
08 _h	Set process data 7	INTEGER16
09 _h	Set process data 8	INTEGER16
0A _h	Set process data 9	INTEGER16
0B _h	Set process data 10	INTEGER16

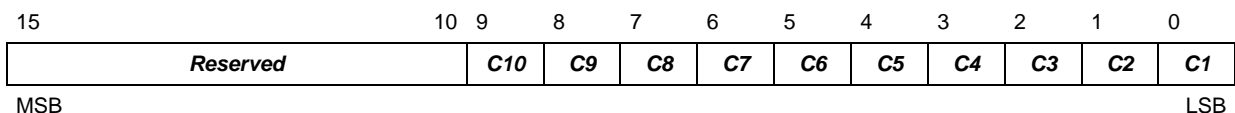

Figure 12 — Controller on/off structure

Table 6 — Value definition for controller on/off

Signal	Value	Definition
C1 to C10 (<i>controller 1 to 10</i>)	0 _b	Controller off



6.2 Predefined communication objects

6.2.1 Object 1000_h: Device type

This object shall provide the type of device and its functionality. For multiple CANopen logical devices the additional information parameter shall contain FFFF_h. In this case, the object 67FF_h shall be implemented.

Multiple CANopen logical devices shall be only allowed for puller or corrugator as first logical device with one saw as second logical device.

Figure 13 specifies the object structure. The device profile number shall be 420_d. Table 7 specifies the device class codes.

Table 8 specifies the specific functions for master-extruder. Table 9 specifies the specific functions for co-extruder downstream device.

Table 10 specifies the specific functions other downstream devices such as puller, corrugator saw, and calibration-table.

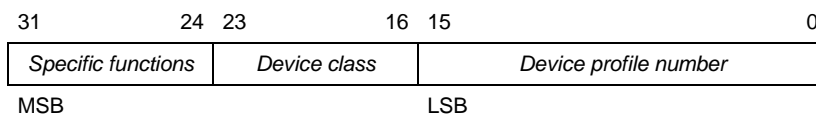

Figure 13 — Object structure

Table 7 — Device class definition

Code	Function
00 _h	Master-extruder
01 _h	Puller
02 _h	Corrugator
03 _h	Saw
04 _h	Co-extruder
05 _h	Calibration-table
06 _h to FE _h	reserved

Table 8 — Specific functions for master-extruder

Code	Function
00 _h	reserved
01 _h	Not compliant to /CiA302-1/ and /CiA302-2/
02 _h	Compliant to /CiA302-1/ and /CiA302-2/
03 _h to FE _h	reserved

Table 9 — Specific functions for co-extruder downstream device

Code	Function
00 _h	reserved
01 _h	Simple co-extruder
02 _h	Advanced co-extruder
03 _h to FE _h	reserved

Table 10 — Specific functions for other downstream devices

Code	Function
00 _h to FE _h	reserved

6.2.2 Object 1001_h: Error register

This object provides the error register as specified in /CiA301/. It is a part of the emergency message. The device profile specific bit shall not be used.

6.2.3 Object 1005_h: COB-ID SYNC

This object shall be implemented. It is specified in /CiA301/. The CAN-ID shall not be changed.

6.2.4 Object 1006_h: Communication cycle period

The master-extruder device shall implement this object. It is specified in /CiA301/.

6.2.5 Object 1014_h: COB-ID emergency object

This object shall be implemented. It is specified in /CiA301/. The CAN-ID shall not be changed.

6.2.6 Object 1016_h: Heartbeat consumer

The master-extruder device shall implement this object. It is specified in /CiA301/.

6.2.7 Object 1017_h: Heartbeat producer

All devices compliant to this profile shall implement this object. It is specified in /CiA301/. The default value shall be between 100_d and 1000_d.

6.2.8 Object 1018_h: Identity

This object provides general information about the device as specified in /CiA301/.

The manufacturer-specific revision number (sub-index 03_h) consists of a major revision number and a minor revision number. The major revision number identifies a specific CANopen behavior. If the CANopen functionality is expanded, the major revision shall be incremented. The minor revision number identifies different versions with the same CANopen behavior.

The revision number (sub-index 03_h) is mandatory and shall indicate the supported profile version; except CiA 420 Part 1. Figure 14 specifies the structure of the revision number. The minor revision number and the major revision number lower byte are manufacturer-specific. The values for the major revision higher byte are specified in Table 11.

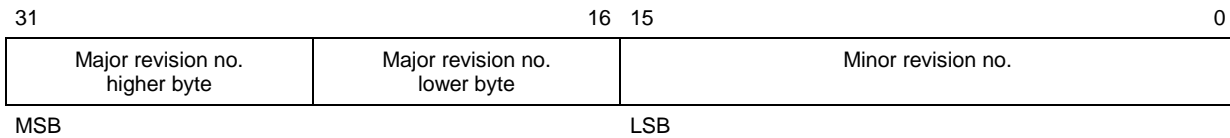

Figure 14 — Structure of revision number

Table 11 — Value definition for the higher byte of mayor revision number

Value [hex]	Definition
1	Compliant to version 1.x
2	Compliant to version 2.x
3	Compliant to version 3.x
4	Compliant to version 4.x
Other values shall be reserved.	

NOTE The subsequent example illustrates the usage of the most significant Byte (MSB) of "Revision number". In case a device designer implements CiA 420 Part 1 V3.1 and CiA 420 Part 5 V2.1, the MSB provides the value 2.

6.2.9 Object 1029_h: Error behavior

This object specifies to which state the device shall be set, in case a communication error or a device-internal error is detected. It is specified in /CiA301/. Table 12 defines the values. Table 13 specifies the object description and

Table 14 specifies the entry description.

Table 12 — Value definition

Value [hex]	State transition
0	NMT pre-operational (only if current state is operational)
1	No state change
2	NMT stopped
Other values shall be reserved.	

Table 13 — Object description

Attribute	Value
Index	1029 _h
Name	Error behavior
Object code	ARRAY
Data type	UNSIGNED8
Category	Optional

Table 14 — Entry description

Attribute	Value
Sub-Index	00 _h
Description	Number of error classes
Access	const
Entry category	Mandatory
PDO mapping	No
Value range	02 _h
Default value	02 _h
Sub-index	01 _h
Description	Communication error
Access	rw
Entry category	Mandatory
PDO mapping	No
Value range	00 _h to 02 _h
Default value	00 _h
Sub-index	02 _h
Description	Internal device error
Access	rw
Entry category	Mandatory
PDO mapping	No
Value range	00 _h to 02 _h
Default value	00 _h

6.2.10 Object 67FF_h: Device type

This objects shall describe the first virtual device in a multiple device module according to /CiA301/.

EUROMAP

Europäisches Komitee der Hersteller von Kunststoff- und Gummi-
maschinen

European Committee of Machinery Manufacturers for the Plastics
and Rubber Industries

Comité Européen des Constructeurs de Machines pour Plastiques
et Caoutchouc

Comitato Europeo Costruttori Macchine per Materie Plastiche e
Gomma

See you again

<http://www.euromap.org>

Copyright by EUROMAP